

transformer relays

SILENT RELAYS

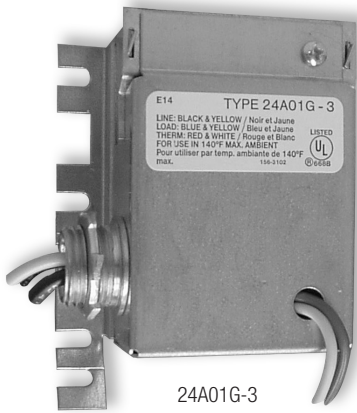

24A01G-3

MODEL	UPC #093319 PART #	TYPE	AMPS
24A01G-3	00535	Single Pole 240/24V Transformer Relay	25
24A05A-1	00543	Single Pole 120/24V Transformer Relay	22
24A05E-1	00540	Single Pole 208/24V Transformer Relay	25
24A05Z-1	00541	Single Pole 277/24V Transformer Relay	25
24A06G-1	00545	2 Circuit 240/24V Transformer Relay	50

These "Level-Temp" controls have been designed to operate with a low-voltage electric heat thermostat to provide a system for controlling electric warm air heaters and electric radiant heating devices such as duct heaters, wall heaters, baseboards, floor and ceiling cable heaters. When required, two or more Level-Temp Silent Operators can be operated by one two-wire low voltage thermostat.

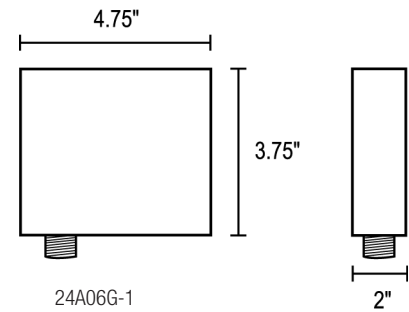
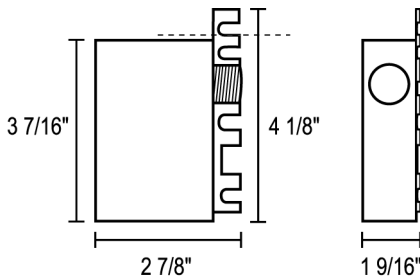

SPECIFICATIONS

Temperature Range:
-20° to 140°F (-29°C to 60°C)

Thermal: Average time delay:
45 seconds

Switch Action: Single pole single throw (normally open)

Accuracy: ±1.5°F, 120V

Power Source:
208VAC - 240VAC,
277 VAC,
50 - 60Hz

Mounting: ½" conduit hub or mounting tabs with several break-offs for 2, 3 or 4 hole mounting.

FEATURES

- Silent remote control of large wattage.
- Loads (heaters) can be accurately done by using these relays.

TECHNICAL

- 25 Amps.
- 240 Volt.
- 24 Volt control.
- ½" Threaded hub.

INSTALLATION

This relay should be installed at the power panel. Other locations include the junction box of the heater or the remote junction box near the heater. When tying relays together make sure they are in phase. Reading zero Volts between low voltage control leads will confirm proper phasing.

transformer relays

24A01G-3 WIRING

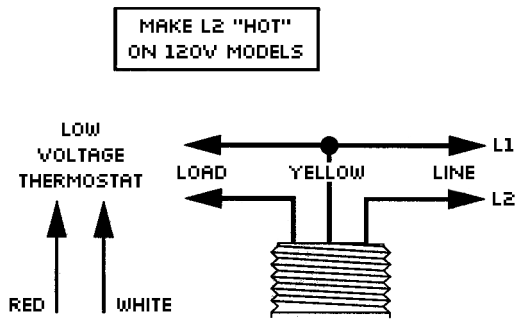

Fig. 1. Diagram of "LEVEL TEMP" wiring

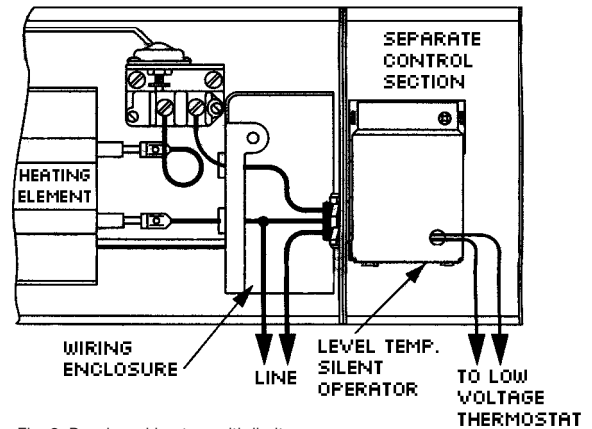

Fig. 2. Baseboard heaters with limit

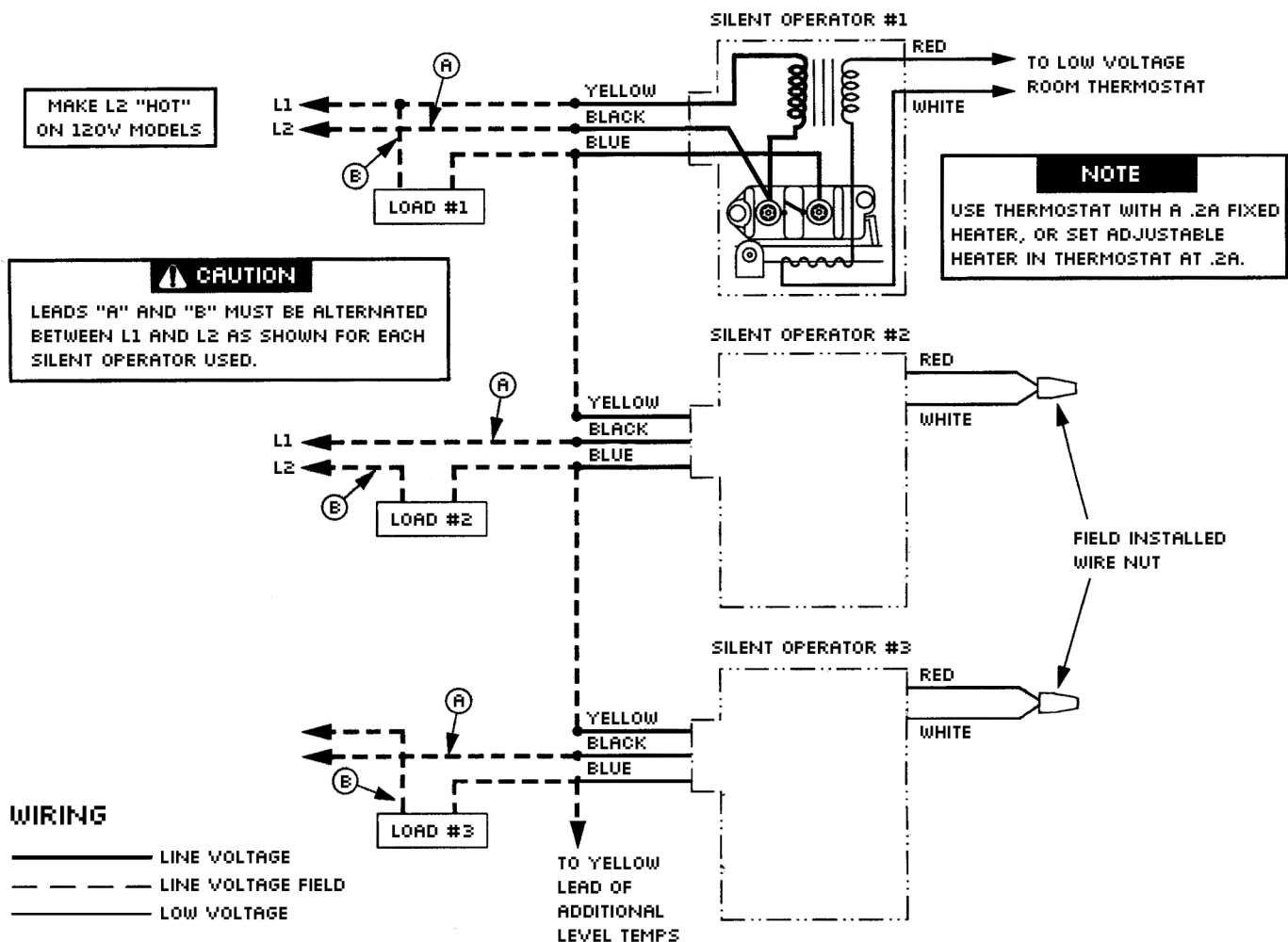

Fig. 3. Typical wiring diagram to "Sequence" two or more loads

transformer relays

MAKE L2 "HOT" ON 120V MODELS

THE THERMOSTAT CIRCUIT CURRENT INCREASES 0.2A FOR EACH ADDITIONAL LEVEL-TEMP. THUS THE HEAT ANTI-CIPATION SHOULD BE 0.2A FOR ONE LEVEL TEMP., 0.4A FOR TWO, 0.6A FOR THREE, ETC. MAX NUMBER OF LEVEL TEMPS IS 5 AND THERMOSTAT CURRENT WOULD BE 1.0 AMPS.

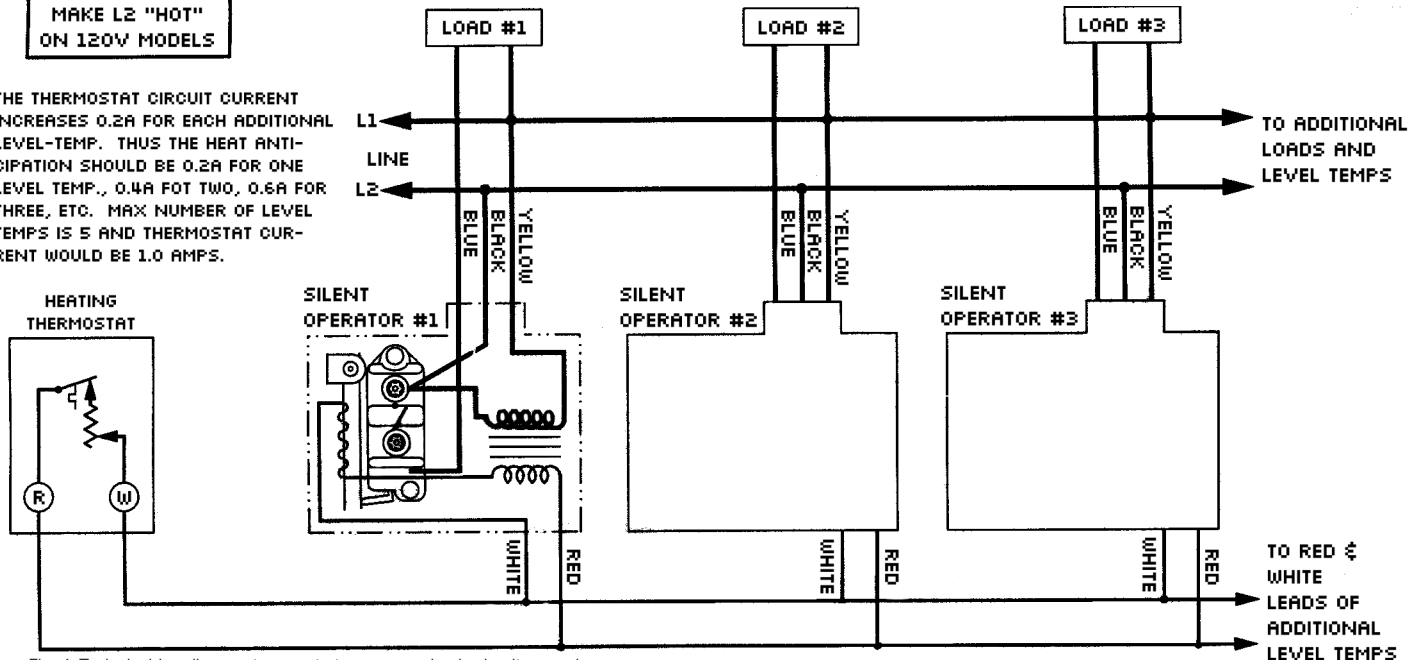

Fig. 4. Typical wiring diagram to operate two or more loads simultaneously

USING ONE THERMOSTAT AND TWO OR MORE SILENT OPERATORS TO "SEQUENCE" LOADS

Figure 3 shows how several Level-Temp Silent Operators can be used to "sequence on" separate heating loads. This may be accomplished by "jumping" the thermostat leads of the additional silent operators, and wiring them in careful conformance to the recommended wiring diagram. Note that only one silent operator is in the thermostat circuit. Therefore, set the adjustable heater in thermostat at .2A, or use a thermostat with a .2A fixed heater.

SEQUENCE OF OPERATIONS: A circuit is completed through the bi-metal heater of the first silent operator as the contacts of the low voltage thermostat close. In approximately 45 seconds, the line voltage snap-switch of this operator closes, energizing heating load #1 and the

transformer primary of silent operator #2. Since the thermostat leads of this operator are "jumped", its bi-metal heater immediately begins its warping action. In approximately 45 seconds the line voltage switch of operator #2 closes to energize heating load #2 and the transformer primary of silent operator #3. This "sequence on" pattern continues until all successive silent operators and heating loads have been energized. When the single Level-Temp room thermostat opens its contacts each separate heating load will be "sequenced off" in intervals of approximately 45 seconds.

OPERATION

Basic Silent Operator components are a line-to-low voltage transformer, a low voltage bi-metal heater, an ambient compensating bi-metal and a normally open single pole single throw line voltage snap-action switch. In operation a circuit is completed through the bi-metal heater as the low voltage room thermostat closes its contacts. In approximately 45 seconds the warping action of the heater closes the line voltage snap-action to energize the heating load. When the thermostat opens its contacts the bi-metal heater cools for approximately 45 seconds before the line voltage switch opens to de-energize the heating load.

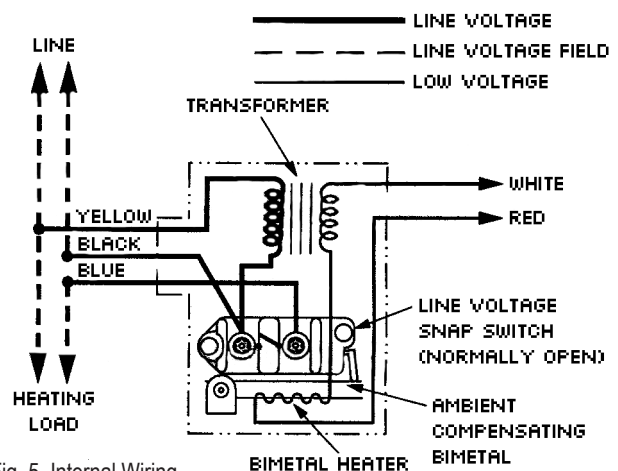

Fig. 5. Internal Wiring