

INSTALLATION AND MAINTENANCE

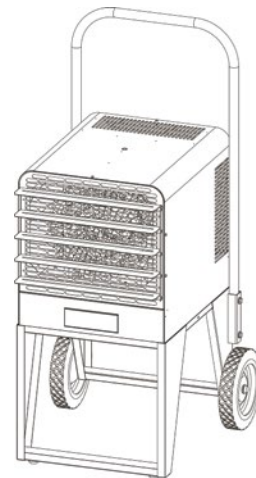

PKB **PLATINUM^X** Series Electronic Portable Heater

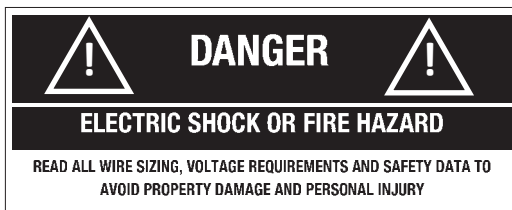

WARNING



READ CAREFULLY - Use the heater only as described in this manual. Any other use is not recommended and could result in fire, electric shock, and personal injury. Following these instructions will prevent difficulties that might occur during the installation and use of the heater. Please study the instructions first, as they may save considerable time and trouble during use addition to providing important safety information. Make sure to save these instructions for future use.

NEVER LEAVE HEATER UNATTENDED WHILE CONNECTED TO A POWER SOURCE

Read all instructions before using this heater

1. **WARNING:** This heater is hot when in use. To avoid burns, do not let bare skin touch hot surfaces. Keep combustible materials, such as furniture, pillows, bedding, papers, clothes, etc. and curtains at least 3 feet (0.9m) from the front of the heater and keep them away from the sides and rear.
2. Extreme caution is necessary when heater is used by or near children or invalids and whenever the heater is left operating and unattended.
3. Always unplug heater when not in use.
4. **WARNING:** Do not operate heater with damaged cord or plug, after it malfunctions, has been dropped, or damaged in any manner. Discard heater or return to authorized service facility for examination and/or repair.
5. **WARNING:** Do not use outdoors.
6. This heater is not intended for use in bathrooms, laundry and similar indoor areas. Never locate heater where it can fall into a bathtub or other water container.
7. **WARNING:** Do not run cord under carpeting. Do Not cover cord with throw rugs, runners or similar coverings. Do not route cord under furniture or appliances. Arrange cord away from traffic area and where it will not be tripped over.
8. To disconnect heater, turn controls to off, then remove plug from outlet.
9. Connect to properly grounded outlets only.
10. **WARNING:** Do not insert or allow foreign objects to enter any ventilation or exhaust opening as this may cause an electric shock or fire, or damage the heater.
11. **WARNING:** To prevent a possible fire, do not block air intakes or exhaust in any manner.
12. **WARNING:** A heater has hot and arcing or sparking parts inside. Do not use it in areas where gasoline, paint, or flammable vapors or liquids are used or stored.
13. Use this heater only as described in this manual. Any other use not recommended by the manufacturer may cause fire, electric shock, or injury to persons.
14. Always plug heater into wall outlet or receptacle. Never use with extension cord or relocatable power tap, or power strip.
15. **WARNING: THIS UNIT SHALL NOT BE USED WITHOUT A DUCT.**
16. **WARNING:** Hyperthermia can result in death. Symptoms of hyperthermia include high body temperature, headache, nausea, vomiting, tiredness, dizziness, fainting, and rapid pulse. If you begin to experience symptoms related to hyperthermia, turn off the heater and seek medical attention.
17. To avoid excessive room temperatures which can cause hyperthermia: **DO NOT** leave product running unattended in a confined space around infants, or individuals with reduced physical, sensory, or mental capabilities.

PKB PLATINUMX ASSEMBLY & SETUP

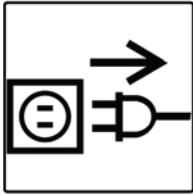

CAUTION!

Remove power by unplugging the Heater while setting up or placing

ITEM NO.	DESCRIPTION	QTY
1	Rubber Bumper Feet	2
2	1/4"-20 Nuts	2
4	Rubber Wheels	2
5	Axel	1
6	Handle Bracket	2
7	Handle	1
9	Push Nut Caps	2
10	Flat Washer	4
11	Lock Washer	4
12	1/4"-20 Hex Bolts	4
13	Nut Plate	2

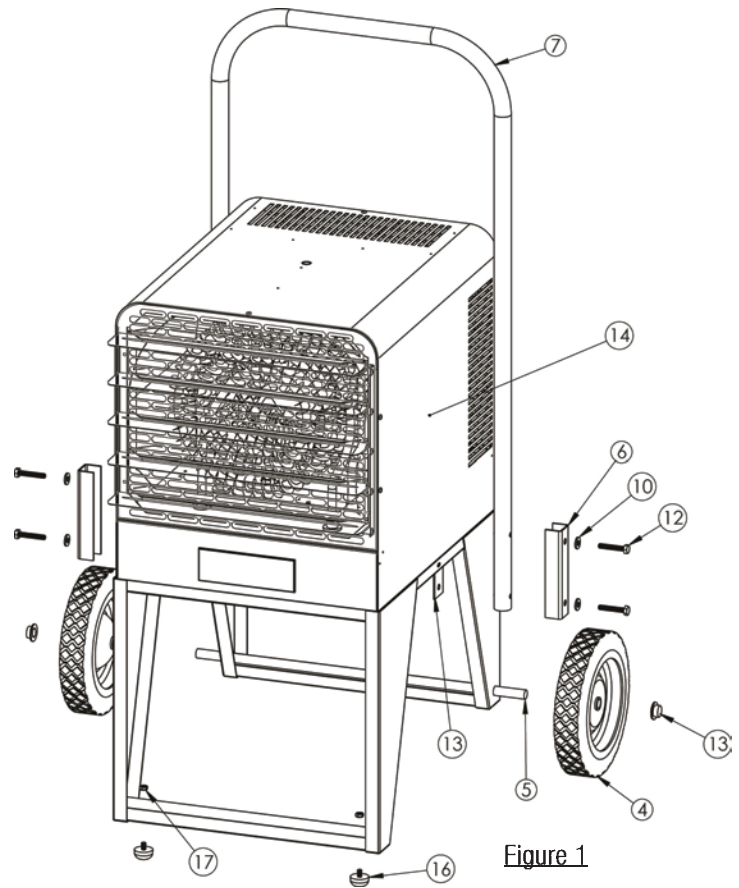

Figure 1

Setting up Your Heater:

Unpack & inspect your heater for any damage. For any damage call King Electrical or return to an authorized service facility immediately.

Install Wheels & Rubber Bumper Feet:

1. Insert **Axel (Item 5)** through the back legs of the heater base.
2. Install 2 pcs **Rubber Wheels (Item 4)** onto the ends of the Axel and use a hammer to secure the **Push Nut Caps (Item 9)** onto the ends.
3. Insert **Rubber Bumper Feet (Item 1)** through the holes in the bottom of the front legs of the heater base and secure in place with the **1/4"-20 Nuts (Items 2)**.

Install Handle:

1. Hold the **Handle (Item 7)** in place while positioning the **Nut Plate (Item 13)** on the backside of the base (smooth side facing handle) and the **Handle Bracket (Item 6)** on the front side of the

base. To secure, insert and tighten the **1/4"-20 Hex Bolts (Item 12)** through a **Lock Washer (Item 11)** and a **Flat Washer (Item 10)** and tighten handle to the base with the following procedure:

Handle Bracket (Item 6) is designed to partially flatten the handle tube to insure a tight fit. The **1/4"-20 Hex Bolts (Item 12)** should be tightened with a 7/16" box or socket wrench. Alternate the tightening sequence equally on each Hex Bolt to ensure equal deformation of the tube. When installed properly, the handle bracket will deform the tube and the side legs of the bracket will just touch the heater base. Do not tighten more than 50 in/lb. of torque or the bolt or nut could strip or break.

Pre-assemble both tube ends loosely to base before tightening bolts.

Final Setup of Heater and General Use:

1. Place heater 6" min. (15cm) away from vertical surfaces and keep intake clear of obstructions. Keep all combustible materials, such as furniture, papers, clothes, drapes, and curtains at least 3 feet (0.9 m) from the front, sides and rear of the heater.

PKB PLATINUMX ASSEMBLY & SETUP

1. Route power cord away from traffic areas to avoid tripping.
NEVER rout cord under carpets, rugs, furniture, other equipment.
2. Plug power cord into a grounded wall outlet only DO NOT use an extension cord or power strip.

WARNING:

This heater is design for floor use ONLY and should not be tipped on side, placed upside down, mounted on or inserted into a wall. A tip-over auto disconnect switch will activate when tipped more then 30°.

DO NOT use heater in areas where gasoline, paint, or other flammable liquids are used.

DO NOT use heater outdoors or in wet or moist indoor areas such as bath or laundry rooms.

ADJUSTMENT OF LOUVERS:

1. Adjust louvers to the desired position prior to operating. See Fig 2

Louver Adjustment: (Do not adjust while heater is operational):

The Louvers are opened during testing at factory, but may have shifted during shipping. Confirm louvers are rotated less than 45 degrees from horizontal before operation. To adjust the opening angle, grasp the left and right end of louver and twist with two hands to the desired position. CAUTION: Increasing the angle beyond 45° degrees from horizontal may restrict air flow casing the over temperature limit to activate and shut off the heater.

Figure 2:

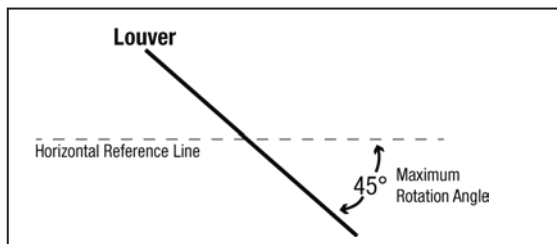

Louver Adjustment

Plug Selection:

Check rating label on heater and verify the proper voltage and SO cord type. The SO cord requires a plug per the chart in Figure 3. No adapter is available for this blade configuration, and none should be used. The type outlet required is grounding outlet. When properly installed, it provides a ground connection through the cord to the heater to protect the operator from electric shock.

Plug Specifications

Fits Cable Dia.	Plug Type	Description	Volts	Amps	Configuration	NEMA #	ANSI #
.385"--.780"	Locking	3 Pole, 4 Wire	250	20		L15-20	C73.85
.385"--.780"	Locking	3 Pole, 4 Wire	250	30		L15-30	C73.86
.595"-1.150"	Locking	3 Pole, 4 Wire	480	30		L16-30	C73.88
.595"-1.150"	Locking	3 Pole, 4 Wire	600	30		L17-30	C73.89
.750"-1.125"	Locking	2 Pole, 4 Wire	600	50		—	—

Figure 3

.750"-1.125"	Locking	3 Pole, 4 Wire	600	50		—	—
.625"-1.187"	Non Locking	2 Pole, 3 Wire	250	50		6-50	C73.53
.390"--.775"	Non Locking	3 Pole, 4 Wire	250	20		15-20	C73.59
.750"-1.250"	Non Locking	3 Pole, 4 Wire	250	50		15-50	C73.61

PKB PLATINUMX SO WIRE SIZE

MODEL #	DESCRIPTION	KW	PHASE	VOLTS	AMPS	SO CORD SIZE
PKB2007-1-P	PKB 208V 7.5KW 1-PH	7.5	1	208	36.1	8/3
PKB2007-3-P	PKB 208V 7.5KW 3-PH	7.5	3	208	20.8	10/4
PKB2010-1-P	PKB 208V 10KW 1-PH	10	1	208	48.0	6/3
PKB2010-3-P	PKB 208V 10KW 3-PH	10	3	208	27.7	8/4
PKB2015-1-P-FB	PKB 208V 15KW 1-PH	15	1	208	72.1	2/3
PKB2015-3-P	PKB 208V 15KW 3-PH	15	3	208	36.1	6/4
PKB2020-3-P-FB	PKB 208V 20KW 3-PH	20	3	208	55.6	4/3
PKB2407-1-P	PKB 240/208V 7.5/5.63KW 1-PH	7.5/5.63	1	240/208	31.3	8/3
PKB2407-3-P	PKB 240/208V 7.5/5.63KW 3-PH	7.5/5.63	3	240/208	18.1	12/4
PKB2410-1-P	PKB 240/208V 10/7.5KW 1-PH	10/7.5	1	240/208	41.7	6/3
PKB2410-3-P	PKB 240/208V 10/7.5KW 3-PH	10/7.5	3	240/208	24.1	10/4
PKB2412-1-P-FB	PKB 240/208V 12/9KW 1-PH	12.5/9.4	1	240/208	52.1	6/3
PKB2412-3-P	PKB 240/208V 12/9KW 3-PH	12.5/9.4	3	240/208	30.1	8/4
PKB2415-1-P-FB	PKB 240/208V 15/11.25KW 1-PH	15/11.25	1	240/208	62.5	4/3
PKB2415-3-P	PKB 240/208V 15/11.25KW 3-PH	15/11.25	3	240/208	36.1	6/4
PKB2420-3-P-FB	PKB 240/208V 20/15KW 3-PH	20/15	3	240/208	48.2	4/4
PKB2425-3-P-FB	PKB 240/208V 25/18.75KW 3-PH	25/18.75	3	240/208	60.2	2/4
PKB2430-3-P-FB	PKB 240/208V 30/22.5KW 3-PH	30/22.5	3	240/208	72.3	2/4
PKB4807-1-P	PKB 480V 7.5KW 1-PH	7.5	1	480	15.6	14/3
PKB4807-3-P	PKB 480V 7.5KW 3-PH	7.5	3	480	9.0	16/4
PKB4810-1-P	PKB 480V 10KW 1-PH	10	1	480	20.8	12/3
PKB4810-3-P	PKB 480V 10KW 3-PH	10	3	480	12	14/4
PKB4812-1-P	PKB 480V 12KW 1-PH	12.5	1	480	26.0	10/3
PKB4812-3-P	PKB 480V 12KW 3-PH	12.5	3	480	15.1	12/4
PKB4815-1-P	PKB 480V 15KW 1-PH	15	1	480	31.3	8/3
PKB4815-3-P	PKB 480V 15KW 3-PH	15	3	480	18.1	12/4
PKB4820-3-P	PKB 480V 20KW 3-PH	20	3	480	24.1	10/4
PKB4825-3-P	PKB 480V 25KW 3-PH	25	3	480	30.1	8/4
PKB4830-3-P	PKB 480V 30KW 3-PH	30	3	480	36.1	6/4

CLEANING INSTRUCTIONS

Before cleaning this heater, heating element must be cool.

1. Before removing grille, turn the electrical power OFF by unplugging it. If not, electricity may still be flowing to the heater. If you are uncomfortable working with electrical appliances consult a qualified electrician. Once power is off completely, proceed to the next step.
2. Remove 4 Phillips head screws located behind the louvers in the corners of the louver housing. Wipe housing with soft cloth or brush.
3. Using a hair dryer or vacuum on blow cy-

cle, blow debris back through the element. Do not touch element. Vacuum loose debris without touching the elements.

4. Replace louver housing and secure with screws.
5. To clean the fan and motor remove the safety grill from the rear of the heater. This provides access to the fan and motor. Wash Grill with hot soapy water and dry immediately
6. Wipe the fan and motor with a soft cloth or brush.
7. Replace safety grill & plug the unit back in.

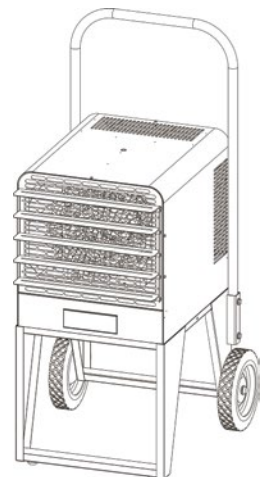

PLATINUMX OPERATING INSTRUCTIONS

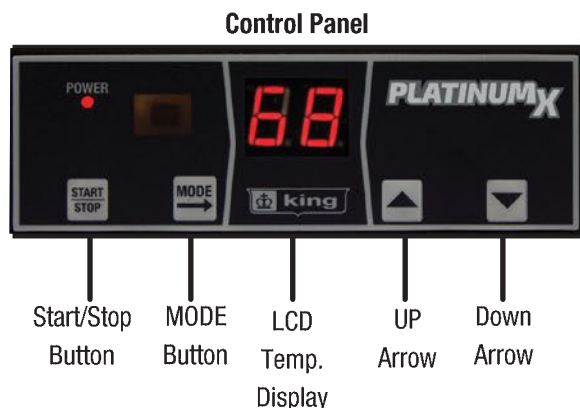



Infrared Remote Control

Operating Instructions

1. Push the  button, the heater will come on and heat to the default setting of 77°F.
2. Once the room temperature reaches the set point, the heater will stop running.
3. In normal operation the display will show the current room temperature.

Room Temperature Selection



- During operation, push  or  arrow buttons to set the temperature from 45°F-99°F, Hold down the UP or DOWN arrow to speed up the selection process. The LCD will go back to display room temperature after 5 seconds.

Timer Mode Selection

- During operation, press the  button 1 time, the display window will show the timer mode setup. Push the UP or DOWN arrows to set the timer from 1 hour—9 hours.

Fan Only Mode Selection

Lower thermostat temperature below the room temp. prior to Fan Only selection.

- During operation, press the  button 2 times, the display window will show H (Heat Mode) or F (Fan Only Mode). Push  to enter Fan Only mode. Push  to enter Heat Mode.

Factory Reset

- During operation, press the and HOLD the  button for 5 seconds to reset to the factory settings.

Sensor Error Code

- During operation, if the display shows E1 that indicates an issue with the sensor. The sensor connector may have come loose from the control board. Open the wiring compartment and reseal the sensor onto the control board. Or it may be possible the sensor needs to be replaced. Contact customer support for assistance.





Smart Heating Solutions