

# **PYROCON19-TRACE**

**Controller and User Interface panel**

**Owner's manual & Technician Settings**



## Index

---

|  |           |
|--|-----------|
| <b>Introduction</b> .....  | <b>3</b>  |
| <b>Wiring diagram for stand alone configuration</b> .....              | <b>4</b>  |
| <b>Connecting PYROCON19-TRACE slaves (option)</b> .....                | <b>5</b>  |
| <b>Operating instructions</b> .....                                    | <b>6</b>  |
| Turning the system ON and OFF .....                                    | 6         |
| Selecting temperature scale.....                                       | 6         |
| Selecting Automatic or Manual mode .....                               | 6         |
| Heaters indication.....  | 6         |
| Snow flake icon and digital time indication.....                       | 6         |
| <b>Technician settings</b> .....                                       | <b>7</b>  |
| Enter technician settings mode.....                                    | 7         |
| P01 - Temperature set point .....                                      | 7         |
| P02 - Lower limit temperature for heating .....                        | 8         |
| P03 -Time delay before stopping the heaters.....                       | 8         |
| P04 - Manual mode ON time.....   | 9         |
| P05 - Heaters cycle and splitting time.....                            | 9         |
| P07 - Heater outputs logic (by Temperature sensor or by Aquastat)..... | 10        |
| P08 – MODBUS MAC Address for BMS and for Master-Slave .....            | 11        |
| P09 - Test conditions mode .....                                       | 12        |
| P11 – Master/Slave .....   | 12        |
| P15 – Temperature sensor calibration offset.....                       | 12        |
| Save changes and return to normal display.....                         | 13        |
| Restore default values .....   | 13        |
| Short measuring times (test only) - DIP switch S2 .....                | 14        |
| Heaters sequencing logic - DIP switches S3 and S4 .....                | 14        |
| Enable/Disable zones .....   | 15        |
| Select Critical zones.....   | 16        |
| <b>BMS – BACnet/Modbus</b> .....                                       | <b>17</b> |
| <b>Temperature readings and Communication errors</b> .....             | <b>17</b> |
| Temperature sensor readings are out of reliable measuring range .....  | 17        |
| Temperature sensor not connected or short circuit .....                | 17        |
| Slaves communication error .....                                       | 17        |
| <b>Object list Modbus</b> .....  | <b>18</b> |
| <b>Object list BACnet</b> .....  | <b>19</b> |

## Introduction

The PYROCON19-TRACE offers smart and simple control for HEAT TRACING SYSTEMS. It can operate up to 4 heating zones and one auxiliary zone, with selectable sequencing method. Typical applications include pipes, valves and gutters.

The backlit LCD screen provides full interface and information to the system status.

The Use of several zones staggering allow covering longer pipes length with less available electrical power.

The PYROCON19-TRACE offers various operating and programming options such as:

- Switchable temperature scales (°F or °C)
- Both Automatic and Manual modes
- Adjustable heaters cycle and splitting times
- Adjustable heaters hold on off delay
- Adjustable Lower ambient temperature limit to stop heaters (lockout)
- Energy saving temperature limit
- Commissioning/Test environment

### PYROCON19-TRACE General system layout with PYROBOX3/5

#### PYROCON19-TRACE

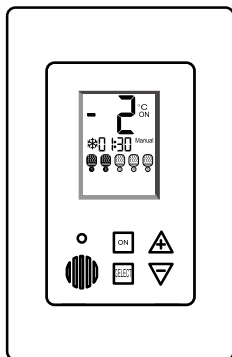

#### PYROBOX3/5

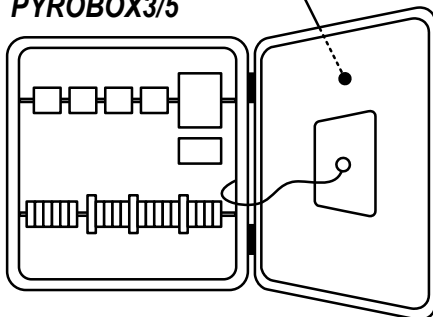

— Aquastat sensor (option)

— Temperature sensor

→ Zone 1

→ Zone 2

→ Zone 3

→ Zone 4

→ Zone 5

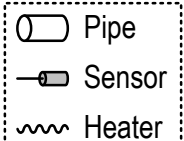

# Wiring diagram for stand alone configuration

**Important!**

The *PYROCON19-TRACE* does not include an integral EGFPD (Equipment Ground Fault Protection Device).

EGFPD needs to be provided in the end application.

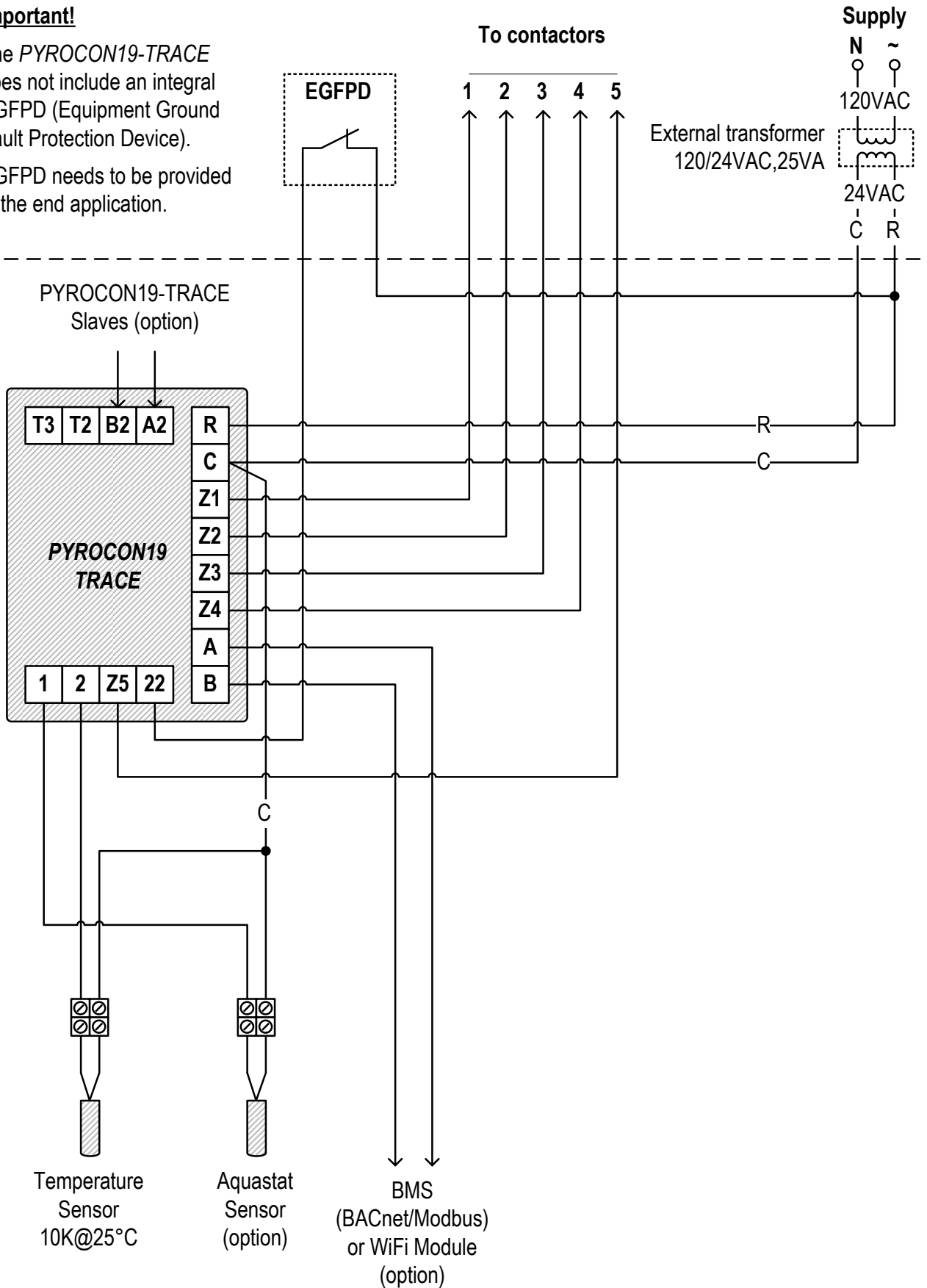

## Connecting PYROCON19-TRACE slaves (option)

| Number of PYROCON19-TRACE Slaves | Master's MAC Addresses | Slave's MAC Addresses |
|----------------------------------|------------------------|-----------------------|
| Up to 3                          | 1-63                   | 14-16                 |

These slaves can be connected directly to A2,B2 terminals on the PYROCON19-TRACE or through multiple PYRO-JBOX junction boxes with built in 50VA, 110~24VAC transformer - Allowing connection and powering up to 3 slaves.

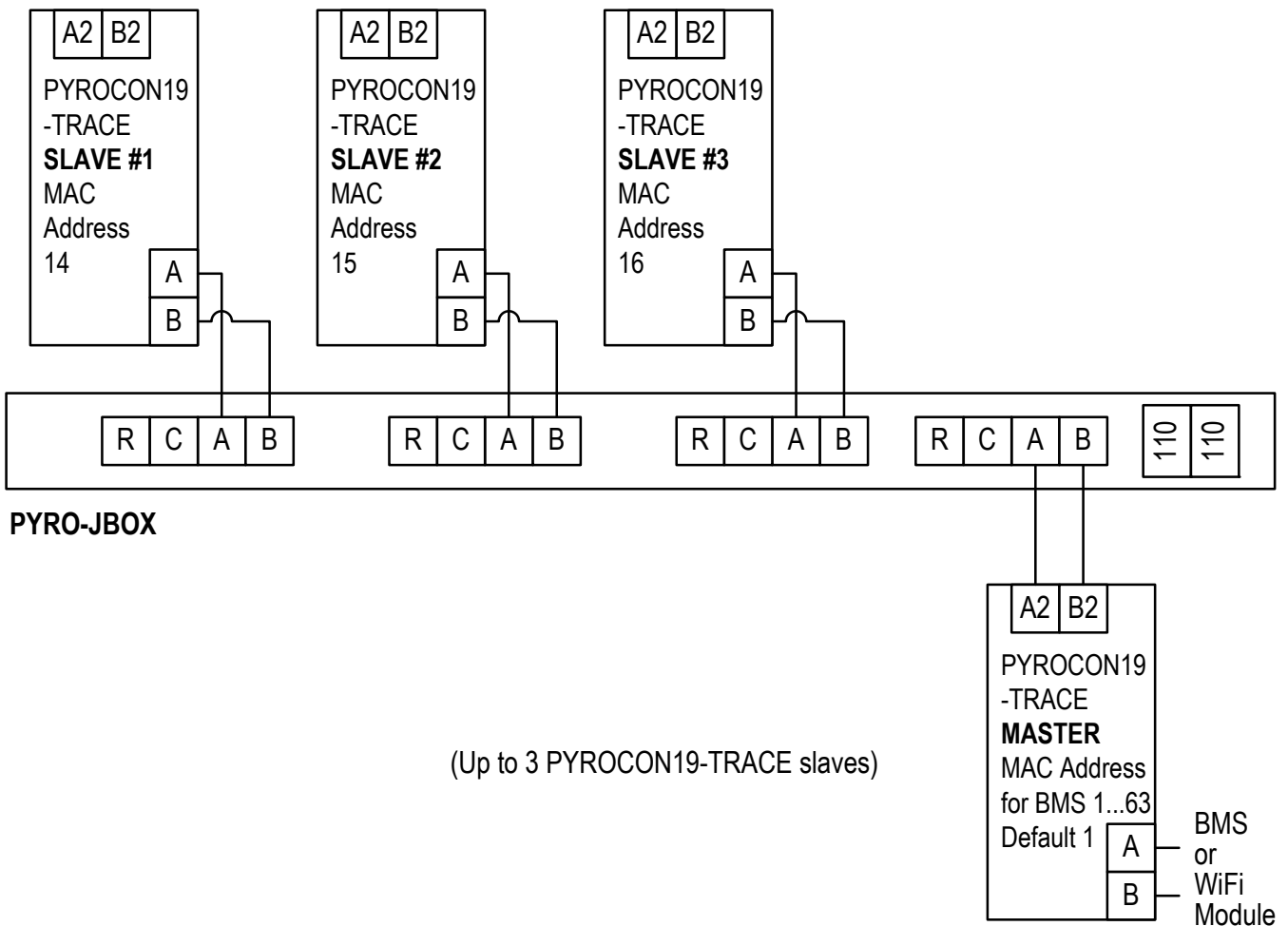

Please refer to technician parameter P08 for Slave's MAC Address.  
and to parameter P11 for Master/Slave configuration

## Operating instructions

### Turning the system ON and OFF

- Press and hold the [ON] button for 0.5 seconds to turn the system ON or OFF.
- The words "ON" or "OFF" will appear on display.

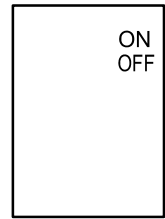

### Selecting temperature scale

- Press the [+] button for Celsius.
- Press the [-] button for Fahrenheit.

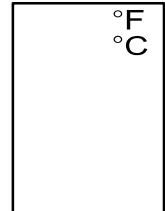

### Selecting Automatic or Manual mode

- Press the [SELECT] button to switch between modes:
  - “Automatic” Heating will start and stop automatically depending on the set point and ambient temperatures.
  - “Manual ON” Heating will start regardless of the set point and ambient temperatures and will stop after a preset time (pls. refer to the “Manual ON” section in the tech. settings).

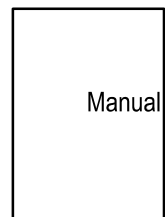
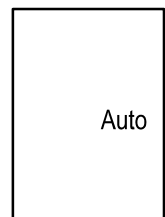

Note: Mode will always return to “Automatic” after switching the unit OFF and ON.

### Heaters indication

The number beneath the heater icon indicate the heater output (1 to 5).

Black icon – Heater ON

White icon – Heater OFF



Output 1   Output 2   Output 3   Output 4   Output 5



Heater ON



Heater OFF

### Snow flake icon and digital time indication

A solid snow flake icon will appear on display during normal heaters operation.



A blinking snow flake icon will appear on display during heaters off delay or when manual mode is activated. The digital clock will count down the remaining time until the heaters are turned off.

The snow flake icon will disappear from display as long as the heaters are turned off.

## Technician settings

Use the technician settings mode to view and adjust the following parameters:

|     |   |     |   |
|-----|---|-----|---|
| P01 | Temperature set point                           | P07 | Heaters outputs logic                     |
| P02 | Lower ambient temperature limit to stop heaters | P08 | MAC Address for BMS and for Master-Slaves |
| P03 | Time delay before stopping the heaters          | P09 | Commissioning / Test mode                 |
| P04 | ON time for manual mode                         | P11 | Master/Slave                              |
| P05 | Heaters cycle time / Splitting time             | P15 | Temperature sensor calibration Offset     |
|     |   |     | Restore defaults                          |

### Enter technician settings mode

- Move DIP switch S1 located on the back side of thermostat to ON position.
- Press the [SELECT] and [+] buttons simultaneously to move forward to the next technician parameter.
- Press the [SELECT] and [-] buttons simultaneously to return to the previous technician parameter.

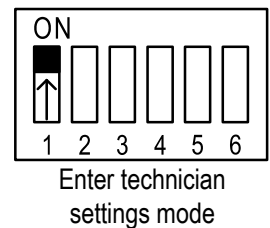

### Save changes and exit technician settings mode

- Move DIP switch S1 located on the back side of thermostat to OFF position.
- The thermostat will return to normal operation mode in OFF state.

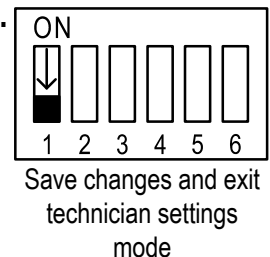

**Important: Changes made to technician parameters will not take effect as long as DIP switch S1 is in ON position.**

### Parameters:

#### P01 - Temperature set point

- Move DIP switch S1 located on the side of thermostat to ON position.
- "P01" and the temperature set point will appear on display.
- Use the [+] and [-] buttons to adjust the temperature set point.  
Range: 14...77°F / -10...+25°C, Default: 37°F / 3°C

As long as the ambient temperature is lower than the temperature set point P01, the PYROCON19-TRACE will turn ON.

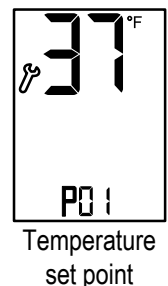

## Technician settings (Cont')

### P02 - Lower limit temperature for heating

- Press the [SELECT] and [+] buttons simultaneously.
- "P02" and the low limit temperature will appear on display.  
When the temperature on the temperature sensor drops below the low temperature limit, the heating system will stop.
- Use the [+] and [-] buttons to adjust the temperature set point.  
Range: -40...+23°F / -40...-5°C    Default: -31°F / -35°C
- Press the [SELECT] and [+] buttons simultaneously again.
- The word "ON" or "OFF" will appear on display.
- Use the [+] and [-] buttons enable (ON) or disable (OFF) the P02 parameter.  
If disabled, the heating system will operate without low temperature limitations.

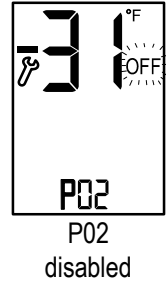
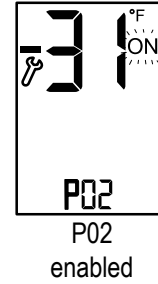
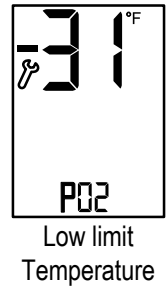

### P03 -Time delay before stopping the heaters

- Press the [SELECT] and [+] buttons simultaneously.
- "P03", "dL" and the time delay before stopping the heaters (Hold ON) will appear on display.
- Use the [+] and [-] buttons to adjust the time delay - Hours.  
Range: 0...9 hours    Default: 1 hour
- Press the [SELECT] and [+] buttons simultaneously again.
- Use the [+] and [-] buttons to adjust the time delay - Minutes.  
Range: 0...59 minutes    Default: 30 minutes

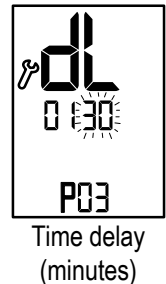
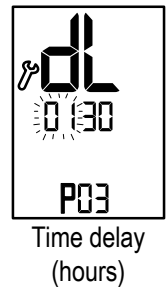

Note 1. The time delay countdown will start when the ambient temperatures rises above the set point temperature.

Note 2. The staggering sequence will continue during the time delay period.

↳ Cont'



## Technician settings (Cont')

### P04 - Manual mode ON time

- Press the [SELECT] and [+] buttons simultaneously.
- "P04", "On" and the "Manual ON" mode time period will appear on display.  
The time frame in which the heaters remain ON after receiving an "Manual ON" command.
- Use the [+] and [-] buttons to adjust the "Manual ON" time (Hours).  
Range: 1...48 hours                      Default: 4 hours
- Press the [SELECT] and [+] buttons simultaneously again.
- Use the [+] and [-] buttons to adjust the "Manual ON" time (Minutes).  
Range: 0...59 minutes                      Default: 30 minutes



### P05 – Heaters cycle and splitting time

- Press the [SELECT] and [+] buttons simultaneously.
- "P05", "SP" and the splitting time will appear on display.  
The minutes will blink.  
The heaters cycle / splitting time parameter defines the working time of the heaters when working in sequence.  
Example: the splitting time is set to 10 minutes and 4 heaters work in sequence, each heater will be ON for 2.5 minutes (10/4=2.5).
- Use the [+] and [-] buttons to adjust the splitting time.  
Range: 1...600 minutes                      Default: 120 minutes.



↳ Cont'

## Technician settings (Cont')

### P07 - Heaters outputs logic (by TEMPERATURE SENSOR or by AQUASTAT SENSOR)

- Press the [SELECT] and [+] buttons simultaneously.
- "P07" and the figures "0", "1", "2" or "3" will appear on display.
- Use the [+] and [-] buttons to define the logic of output 1-5 as follows:

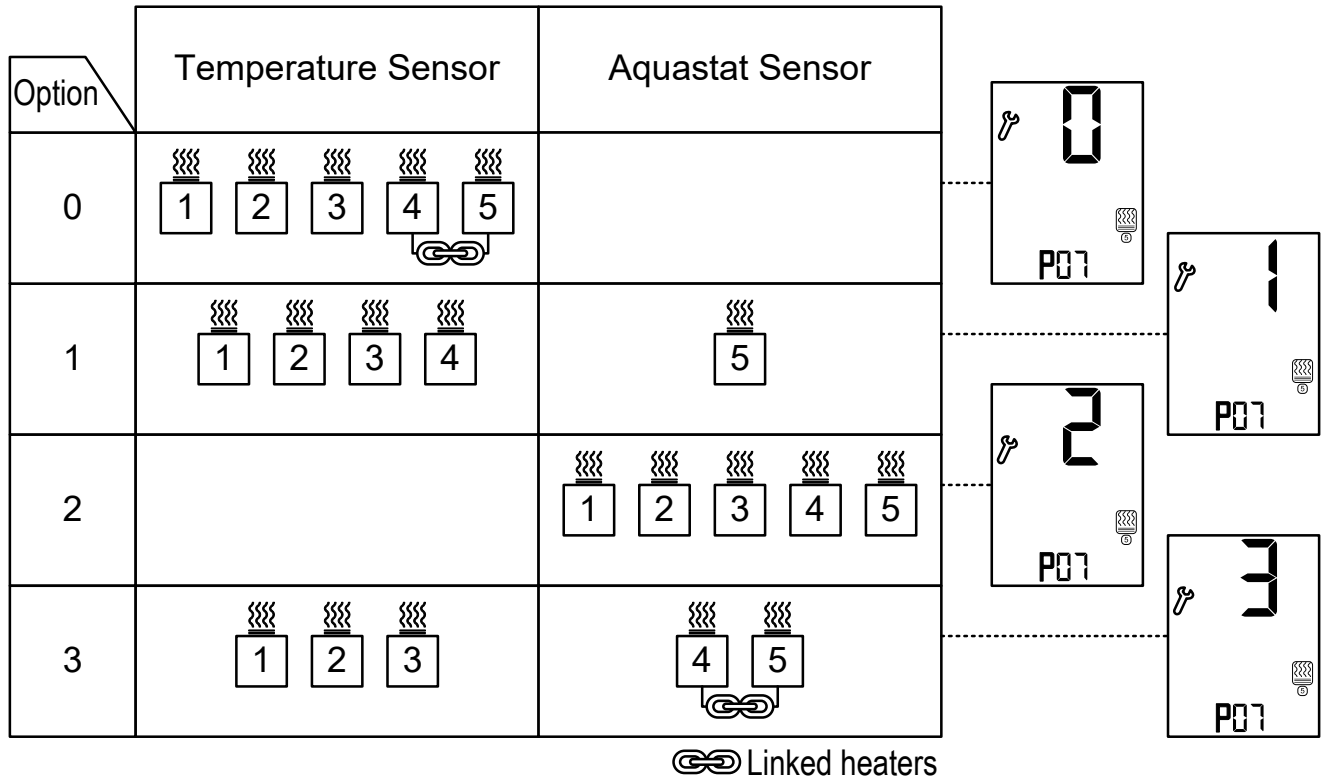

Note: If option 2 is selected, the temperature display will remain blank.

↳ Cont'

## Technician settings (Cont')

### P08 – MAC Address for BMS and for Master-Slaves

- Press the [SELECT] and [+] buttons simultaneously.
- “P08” and the MAC Address will appear on display.
- Use the [+] and [-] buttons to set the MAC Address of the unit.

Setting the MAC address for the unit will make it available through the home automation system.

- For controller set by P11 as Master –  
Address range for BMS 1...63, default 1
- For controller set by P11 as Slave –  
Address range 14...16, default 14

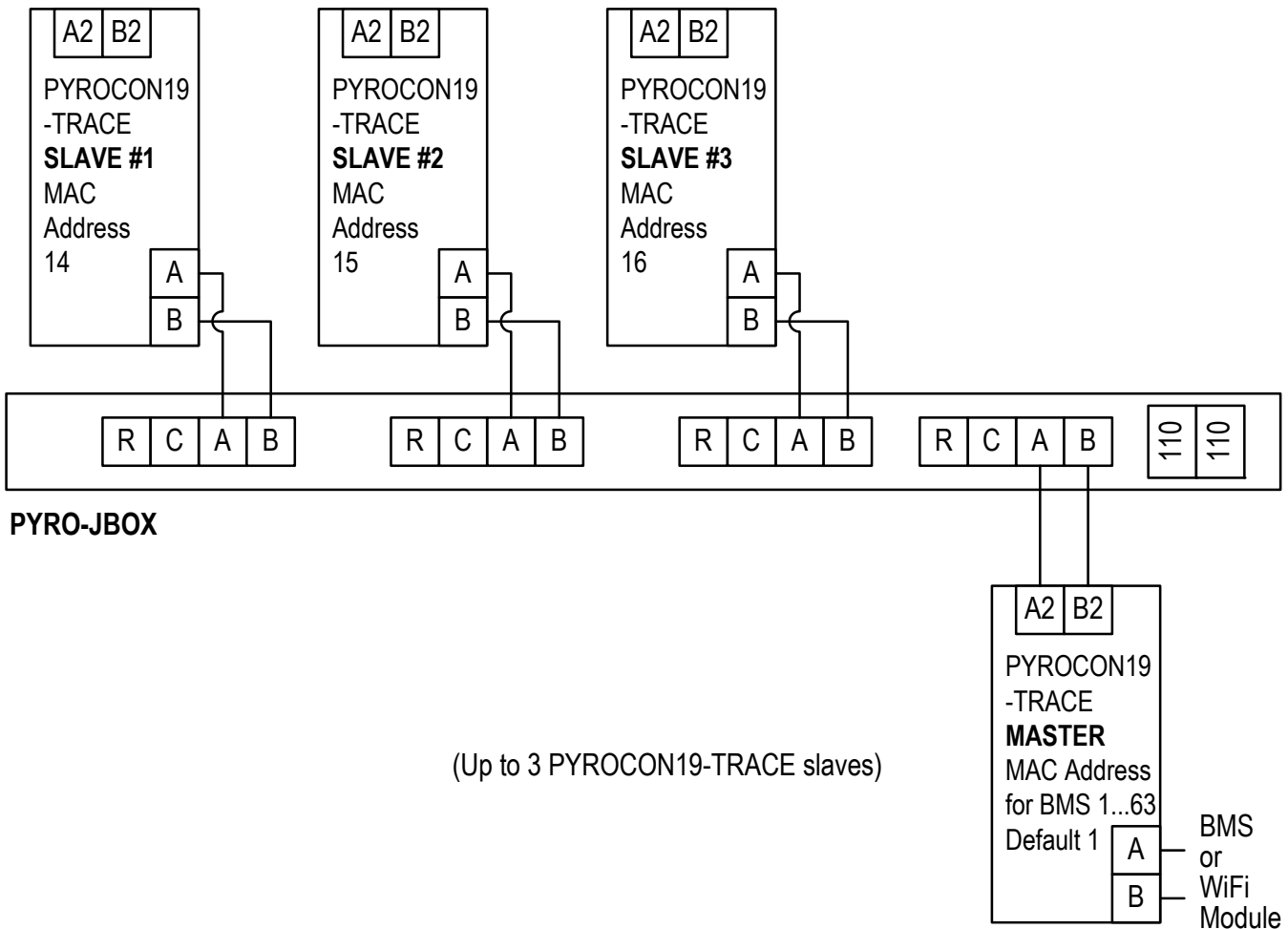
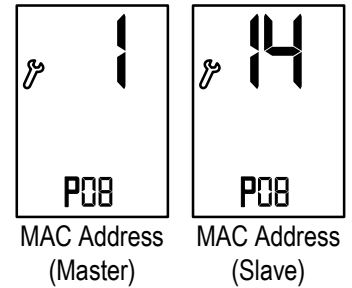

↳ Cont'

## Technician settings (Cont')

### P09 - Test conditions mode / Technician commissioning mode

Turn ON test conditions to check the functionality of the system regardless of temperature sensors parameters (i.e. during the summer).

In test conditions, the Ambient temperature is always  $-7^{\circ}\text{C}/19^{\circ}\text{F}$ .

- Press the [SELECT] and [+] buttons simultaneously.
- "P09" will appear on display.
- Use the [+] button to enter test/commissioning mode – the word "Test" will appear on display.
- Use the [-] button to manually exit test/commissioning mode – the word "Test" will disappear from display.

Note: If the technician did not manually exit test/commissioning mode, the unit will automatically return to normal mode after 5 hours.

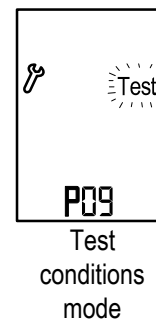

### P11 – Master/Slave

- Press the [SELECT] and [+] buttons simultaneously.
- "P11" will appear on display.
- Use the [+] and [-] buttons to select between:
  - "MA" - Master (When using one PYROCON19-TRACE or when controlling other PYROCON19-TRACE devices connected to A2,B2 as slaves) - default
  - "SL" - Slave (controlled by another PYROCON19-TRACE connected to A,B)

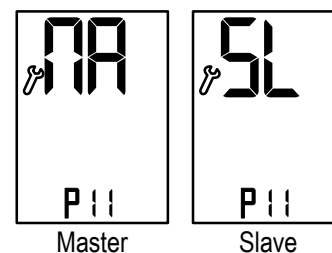

### P15 – Temperature sensor calibration offset

- Press the [SELECT] and [+] buttons simultaneously.
- "P10" will appear on display.
- Use the [+] button to adjust the offset for calibration of measured temperature.  
Range:  $-9...+9^{\circ}\text{F}$  /  $-6...+6^{\circ}\text{C}$       Default:  $0^{\circ}\text{F}$  /  $0^{\circ}\text{C}$

Note: If the technician did not manually exit test/commissioning mode, the unit will automatically return to normal mode after 5 hours.

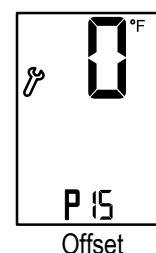

↳ Cont'

## Technician settings (Cont')

---

### Save changes and return to normal display

---

- In order to save changes and return to normal display, move DIP switch S1 back to OFF position.

**Important: Changes made to technician parameters will not take effect as long as DIP switch S1 is in ON position.**

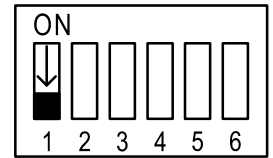

Save changes and exit technician settings mode

### Restore default values

---

- Move DIP switch S1 to ON position.
- Press and hold the [ON] button for 10 seconds. The thermostat will beep.
- Move DIP switch S1 back to OFF position.

## Technician settings (Cont')

### Short measuring times (test only) - DIP switch S2

- Use DIP switch S2 to short the
  - “ON” - Short measuring times – for test/commissioning only (measuring times will be divided by 60).
  - “OFF” - Normal operation.

Short measuring times: A real 1 hour will take 1 minute and a real 1 minute will take 1 second.

### Heaters sequencing logic - DIP switches S3 and S4

- Use DIP switches S3 and S4 to define the sequencing logic of the heater (zones) as follows:

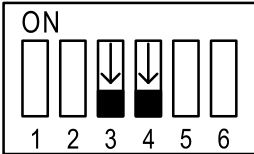

S3 OFF, S4 OFF

All 4 outputs work per request from the temperature sensor

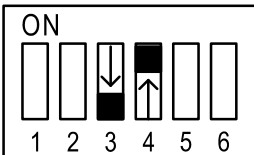
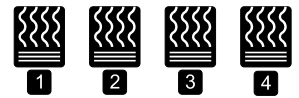

S3 OFF, S4 ON

Outputs 1+3 and outputs 2+4 work together (according to splitting time)

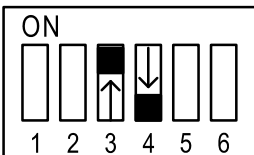
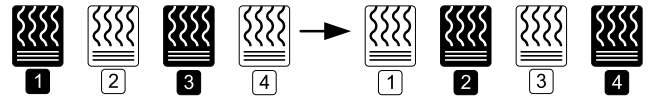

S3 ON, S4 OFF

Outputs 1,2 and 3 work in sequence (according to splitting time) and output 4 works continuously.

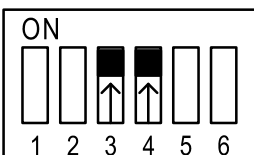
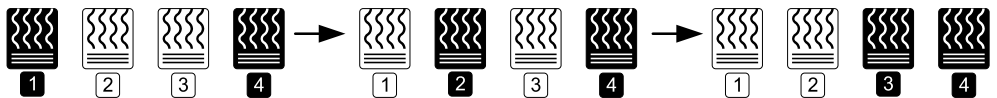

S3 ON, S4 ON

All 4 outputs work in sequence (according to splitting time)

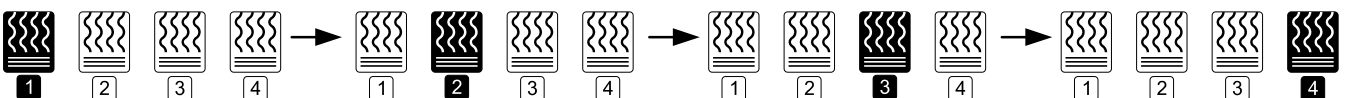

Note: if output 5 is set to work together with outputs 1-4, (see “Heater output no. 5 logic” in the technician settings), it will operate the same as output 4.

## Technician settings (Cont')

### Enable/Disable zones

Follow the steps below to enable or disable each of the 5 zones.

By default, all zones are enabled.

1. Turn the thermostat OFF.
2. Press and hold both the [+] and the [-] buttons simultaneously for 10 seconds.
3. Choose the required zone using the [Select] button. Selected zone number will appear on display and the heater icon will flash.
4. Use the [+] button to enable the selected zone (black heater icon).
5. Use the [-] button to disable the selected zone (white heater icon).
6. Repeat steps above 3 to 5 for any required zone.
7. Press and hold both the [+] and the [-] buttons simultaneously again for 5 seconds to return to normal display.

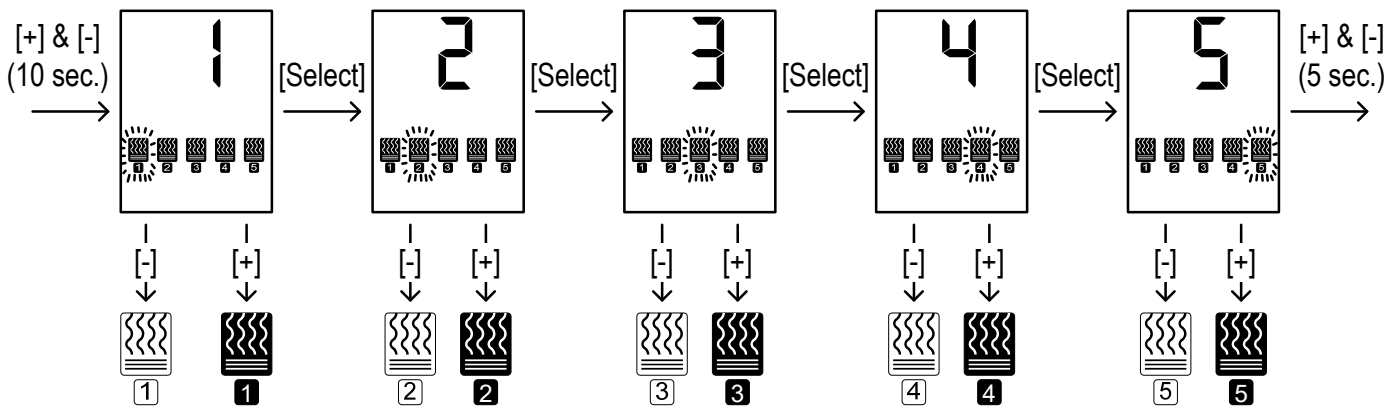

 Black icon – Zone enabled  
1

 White icon – Zone disabled  
1

## Technician settings (Cont')

### Select Critical zones

Follow the steps below to set each of the active zones as Critical or Non-critical zone.

By default, all zones are critical.

1. Turn the thermostat **ON**.
2. Press and hold both the [+] and the [-] buttons simultaneously for 10 seconds.
3. Choose the required zone using the [Select] button. Selected zone number will appear on display and the heater icon will flash.
4. Use the [+] button to set zone as Critical zone ("ON" will appear on display).
5. Use the [-] button to set zone as Non Critical zone ("OFF" will appear on display).
6. Repeat steps above 3 to 5 for any required zone.
7. Press and hold both the [+] and the [-] buttons simultaneously again for 5 seconds to return to normal display.

Note: As long as the ambient temperature is less than the set point, only critical zones will participate in the staggering scenario.

Once the set point is reached, the active zone will complete its cycle followed by one more full cycle of each critical zone (including another full cycle of the active zone).

After that, and for the rest of the "time delay before stopping the heaters" set by parameter P04, the system will start staggering between the non-critical zones .

Example:

- Zones 1,2,3,4 enabled
- Zones 1,2 Critical
- Zones 3,4 Non-critical
- Sequencing logic 1+3 together, 2+4 together
- Time delay before stopping the heaters: P04 = 9 hours.

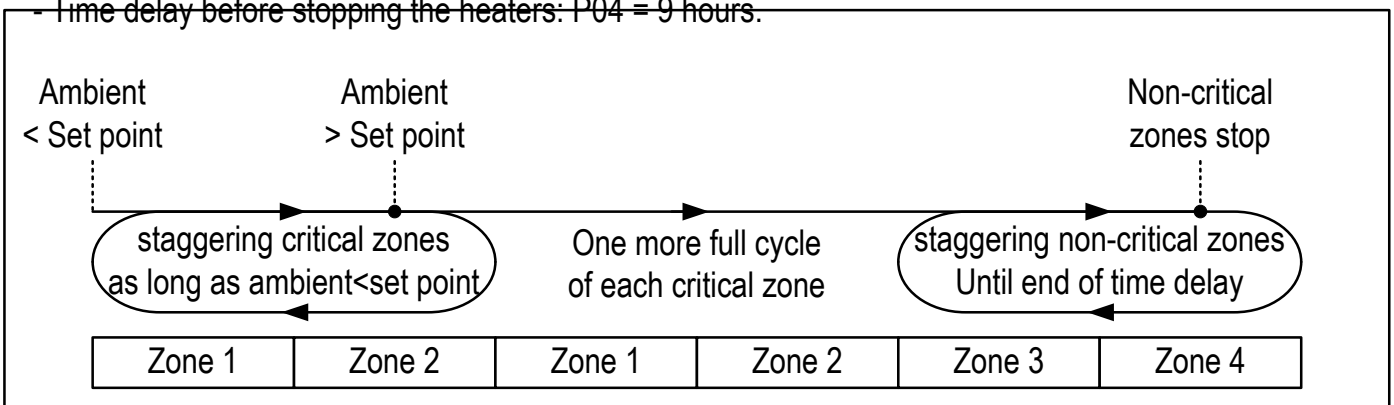



## BMS – BACnet/Modbus

- Use DIP switch S6 located on the side of thermostat to select BMS (A1,B1) network protocol:

- S6 ON – BACnet
- S6 OFF - MODBUS

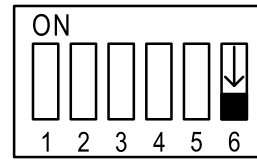

Modbus

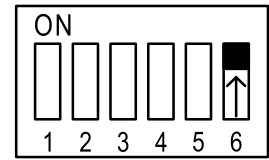

BACnet

## Temperature readings and Communication errors

### Temperature sensor readings is out of reliable measuring range

Low temperature readings: Ambient temperature < -9°F/-23°C

High temperature readings: Ambient temperature > 54°F/12°C

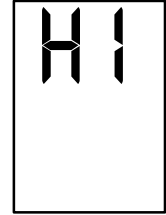
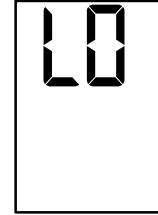

The system will continue to operate using constant predefined values.

In addition, the display will alternate between “LO” and -11°F/-24°C for low temperature readings, and between “HI” and 55°F/13°C for high temperature readings.

### Temperature sensor is not connected or short circuit

“SensErr 2” Will appear on display.

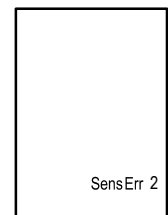

Temperature  
Sensor error

### Slaves – Communication error

#### Aux1 - Slaves communication error

“Aux1” and “00” Will appear on display.

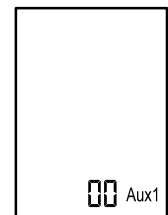

Slaves  
communication  
error

## Object list - Modbus

- Use DIP switch S6 located on the side of thermostat to select BMS (A1,B1) network protocol - S6 OFF – Modbus

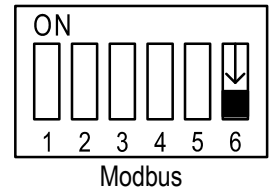

MODBUS RTU Mode, Address Slave 1-127,  
Baud rate: 9600, n, 8, 1

Supported Commands:

0x03 = Read Holding Registers (for all).

0x06 = Preset Single Register (For R/W registers only),

Command 0x2B is used to identify controller

Vendor Url

= "meitavtec.com"

VendorName

= "Meitav-Tec".

ProductCode

= "20420801"

MajorMinorRevision

= "V 20420801.3119"

| N° | Address   | Value                   | Object Name              | Default       | Access |
|----|-----------|-------------------------|--------------------------|---------------|--------|
| 1  | 0 [0x00]  | -40...35°C (-40...95°F) | TemperatureOutside       | -             | R      |
| 2  | 1 [0x01]  | -10...25°C (14...77°F)  | SetPoint                 | 3°C (37°F)    | R/W    |
| 3  | 2 [0x02]  | -40...0°C (-40...32°F)  | LowLimitHeat             | -35°C (-31°F) | R/W    |
| 4  | 3 [0x03]  | 1...540 min             | HeatersOffDelay          | 30 min        | R/W    |
| 5  | 4 [0x04]  | 10...2880 min           | ManualPeriodTime         | 40 min        | R/W    |
| 6  | 5 [0x05]  | 4...600 min             | StaggeringTime           | 20 min        | R/W    |
| 7  | 6 [0x06]  | 0...2                   | TemperatureAquastatLogic | 0             | R/W    |
| 8  | 7 [0x07]  | 0...4                   | HeaterMode               | 0             | R/W    |
| 9  | 8 [0x08]  | 1-On,0-Off              | CommissioningMode        | 0-Off         | R/W    |
| 10 | 9 [0x09]  | 1-On,0-Off              | Heater 1                 | -             | R      |
| 11 | 10 [0x0A] | 1-On,0-Off              | Heater 2                 | -             | R      |
| 12 | 11 [0x0B] | 1-On,0-Off              | Heater 3                 | -             | R      |
| 13 | 12 [0x0C] | 1-On,0-Off              | Heater 4                 | -             | R      |
| 14 | 13 [0x0D] | 1-On,0-Off              | Heater 5                 | -             | R      |
| 15 | 14 [0x0E] | 1-On,0-Off              | Aquastat_Signal          | -             | R      |
| 16 | 15 [0x0F] | 1-On,0-Off              | SettingMode              | -             | R      |
| 17 | 16 [0x10] | 1-On,0-Off              | ShortTimeMode            | -             | R      |
| 18 | 17 [0x11] | 1-On,0-Off              | StageringMode            | -             | R      |
| 19 | 18 [0x12] | 1-On,0-Off              | StageringMode            | -             | R      |
| 20 | 19 [0x13] | 1-On,0-Off              | OnOff                    | 0-Off         | R/W    |
| 21 | 20 [0x14] | 1-On,0-Off              | C_F_Scale                | 0-Off         | R/W    |
| 22 | 21 [0x15] | 1-On,0-Off              | RestoreDefaults          | 0-Off         | R/W    |
| 23 | 22 [0x16] | 1-On,0-Off              | GroundFault              | 0-Off         | R      |
| 24 | 23 [0x17] | -40...35°C (-40...95°F) | InternalTemperature(T3)  | -             | R      |
| 25 | 24 [0x18] | 1-On,0-Off              | InternalHeater           | -             | R      |

The MODBUS Register No. X is addressed in the MODBUS Register Address (PDU) X-1.

**All Registers are signed Integer 16 bit.**

## Object list - BACnet

- Use DIP switch S6 located on the side of thermostat to select BMS (A1,B1) network protocol - S6 ON – BACnet

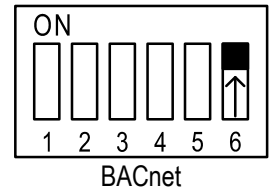

BACnet MST5 Baud rate: 9600, 19200, 38400, 76800 no parity, 8 data bits, 1stop bit

| N° | Object          | Value                   | Object Name                | Default       | Access |
|----|-----------------|-------------------------|----------------------------|---------------|--------|
| 1  | AnalogValue_#0  | -10...25°C (14...77°F)  | SetPoint                   | 3°C (37°F)    | R/W    |
| 2  | AnalogValue_#1  | -40...0°C (-40...32°F)  | LowLimitHeat               | -35°C (-31°F) | R/W    |
| 3  | AnalogValue_#2  | 1...540 min             | HeatersOffDelay            | 30 min        | R/W    |
| 4  | AnalogValue_#3  | 10...2880 min           | ManualPeriodTime           | 40 min        | R/W    |
| 5  | AnalogValue_#6  | 4...600 min             | StaggeringTime             | 20 min        | R/W    |
| 6  | AnalogValue_#7  | -40...35°C (-40...95°F) | TemperatureOutside         | -             | R      |
| 7  | AnalogValue_#8  | 0...2880 min            | HeatersOffTimeDelay        | -             | R      |
| 8  | AnalogValue_#9  | 0...4                   | HeaterMode                 | 0             | R/W    |
| 9  | AnalogValue_#29 | 0...2                   | TemperatureAquastatLogic   | 0             | R/W    |
| 10 | AnalogValue_#20 | -40...35°C (-40...95°F) | InternalTemperature(T3)    | -             | R      |
| 11 | AnalogValue_#24 | 1... 4194303            | BacnetDeviceInstanceNumber | 315000+MAC    | R/W    |
| 12 | BinaryInput_#2  | 1-On,0-Off              | SettingMode                | -             | R      |
| 13 | BinaryInput_#3  | 1-On,0-Off              | ShortTimeMode              | -             | R      |
| 14 | BinaryInput_#4  | 1-On,0-Off              | StageringMode              | -             | R      |
| 15 | BinaryInput_#5  | 1-On,0-Off              | StageringMode              | -             | R      |
| 16 | BinaryInput_#8  | 1-On,0-Off              | Aquastat_Signal            | -             | R      |
| 17 | BinaryOutput_#0 | 1-On,0-Off              | Heater 1                   | -             | R      |
| 18 | BinaryOutput_#1 | 1-On,0-Off              | Heater 2                   | -             | R      |
| 19 | BinaryOutput_#2 | 1-On,0-Off              | Heater 3                   | -             | R      |
| 20 | BinaryOutput_#3 | 1-On,0-Off              | Heater 4                   | -             | R      |
| 21 | BinaryOutput_#4 | 1-On,0-Off              | Heater 5                   | -             | R      |
| 22 | BinaryOutput_#5 | 1-On,0-Off              | InternalHeater             | -             | R      |
| 23 | BinaryValue_#0  | 1-On,0-Off              | OnOff                      | 0-Off         | R/W    |
| 24 | BinaryValue_#2  | 1-On,0-Off              | C_F_Scale                  | 0-Off         | R/W    |
| 25 | BinaryValue_#4  | 1-On,0-Off              | CommissioningMode          | 0-Off         | R/W    |
| 26 | BinaryValue_#5  | 1-On,0-Off              | RestoreDefaults            | 0-Off         | R/W    |
| 27 | BinaryValue_#14 | 1-On,0-Off              | GroundFault                | 0-Off         | R      |



**Tel: (856) 2882882**

**Tel: +972-3-9626462**

**Fax: +972-3-9626620**

**support@meitavtec.com**

**www.meitavtec.com**